

PL11 – Montage- und Bedienungsanleitung

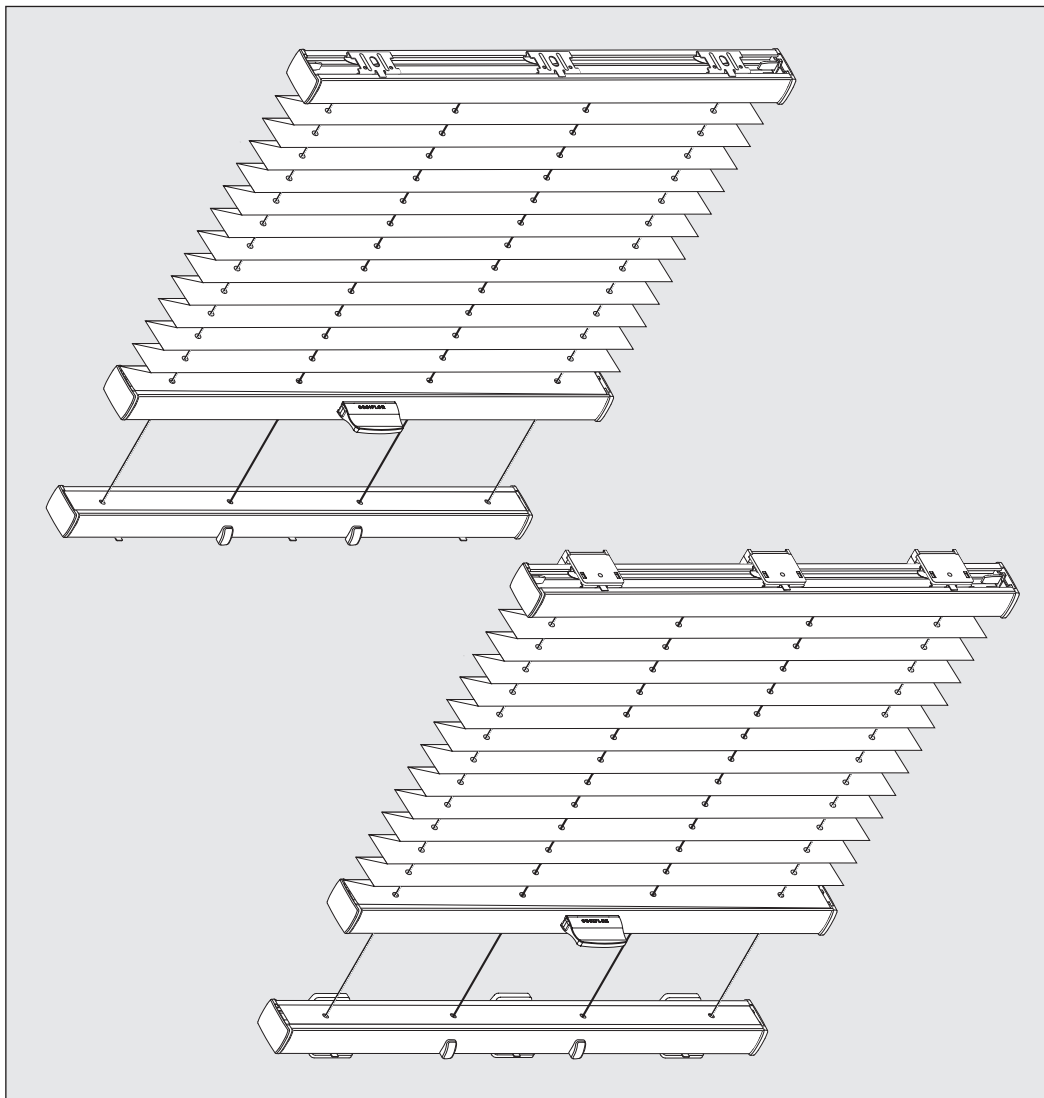

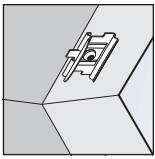

Falzmontage

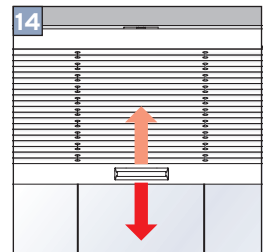
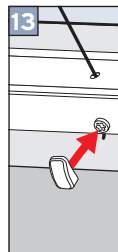
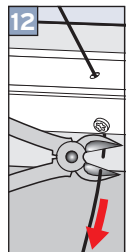
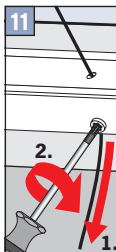
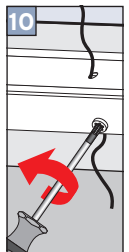
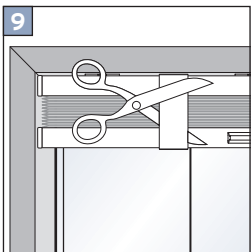
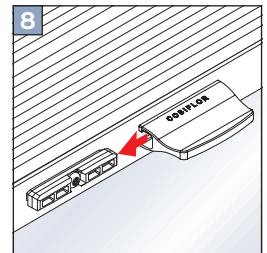
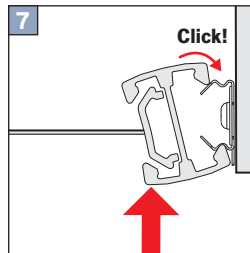
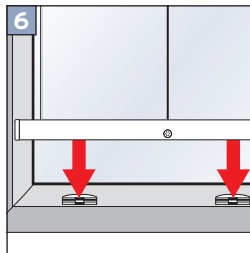
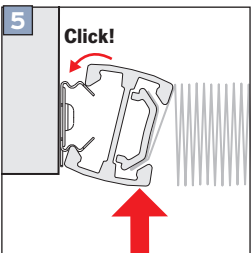
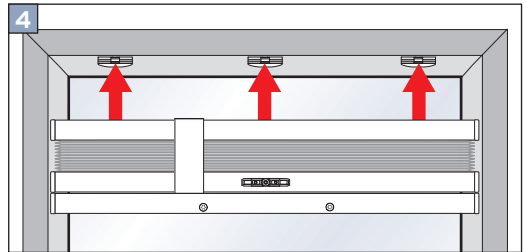
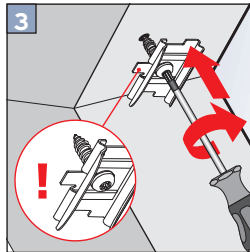
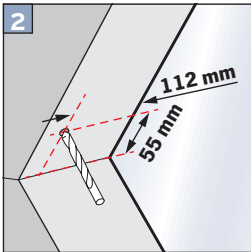
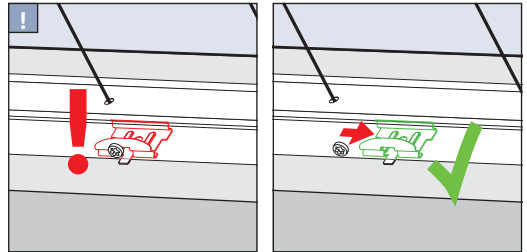
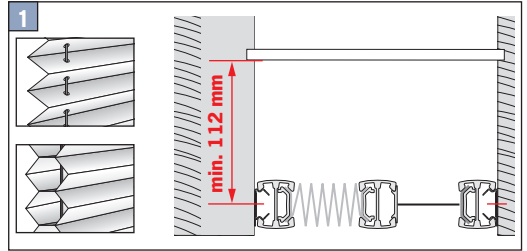
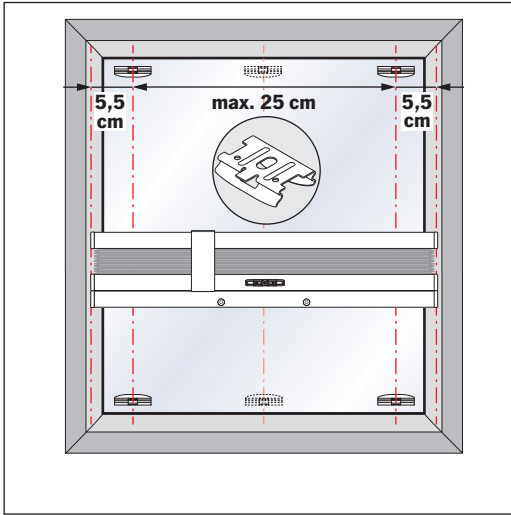
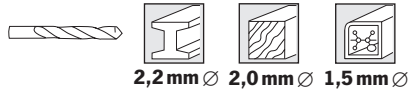

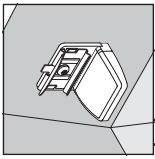

Winkelmontage

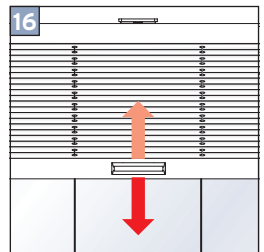
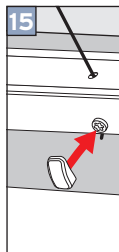
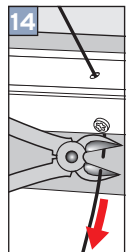
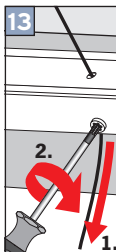
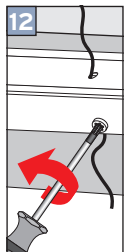
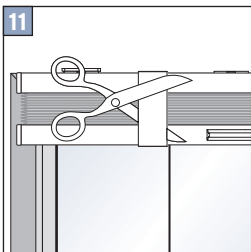
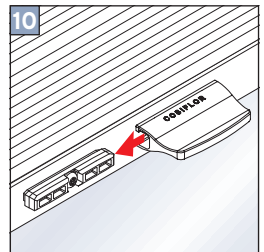
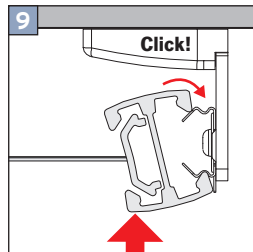
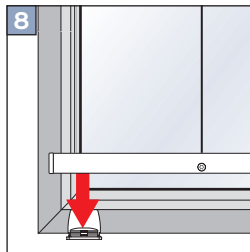
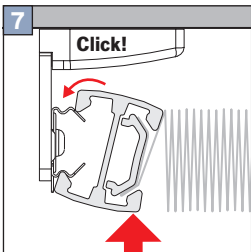
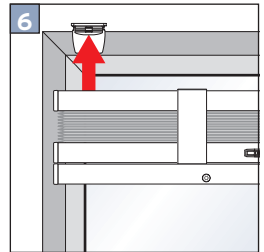
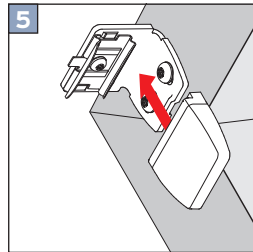
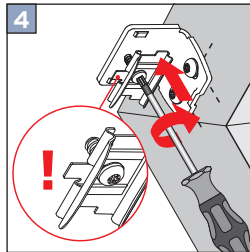
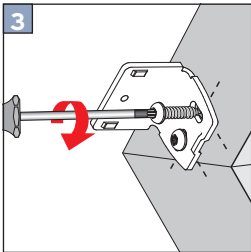
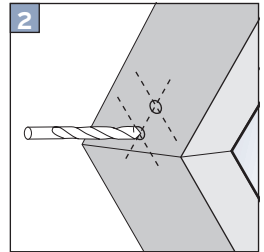
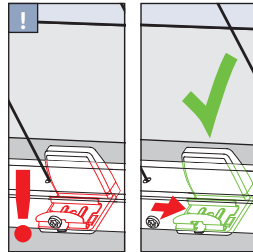
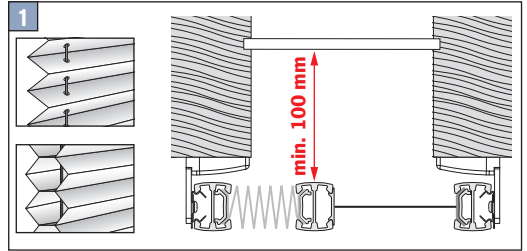
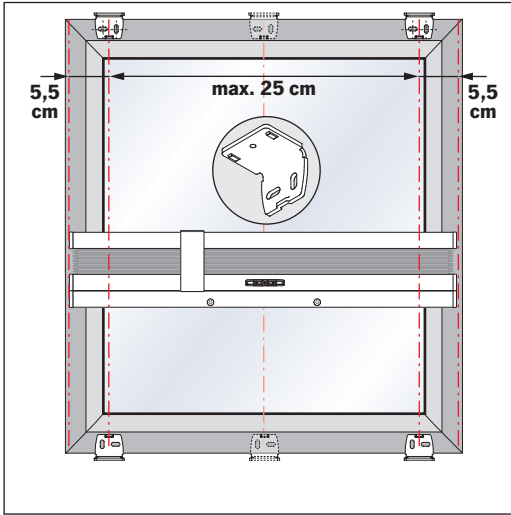

DEMONTAGE

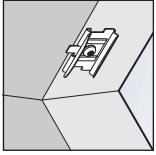

Falzmontage

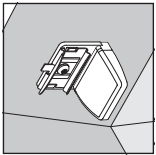
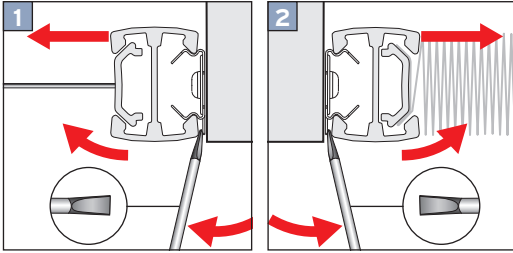

Winkelmontage

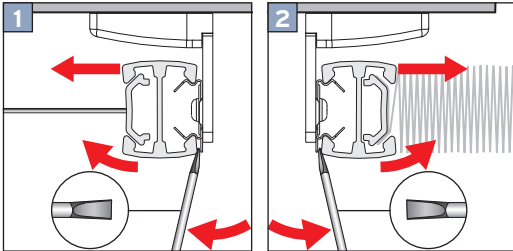

Optional: Bedienung mit Bedienstab

